

Nabtesco

Operation Manual

Neco[®] gearbox series

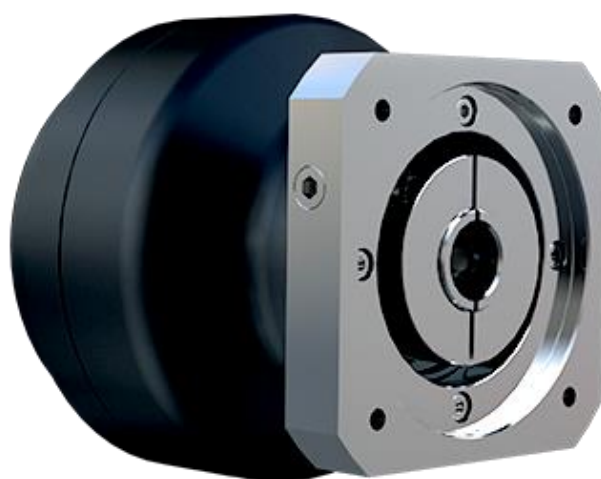

Contents

1	General information	4
1.1	Using this operation manual	4
1.2	Warnings	4
1.3	Safety and hazard signs	5
1.4	Information signs.....	6
1.5	Disclaimer.....	6
1.6	Copyright.....	6
2	Safety instructions	7
2.1	Intended use.....	7
2.2	Foreseeable misuse.....	7
2.3	Installation conditions	7
2.4	Guidelines.....	8
2.5	Qualifications of personnel.....	8
2.6	General safety instructions	8
3	Description of the gearbox	11
3.1	Structure	11
3.2	Technical specifications.....	12
3.3	Product code	12
3.4	Label.....	12
3.5	Lubrication.....	13
4	Storage and transport	15
4.1	Scope of supply	15
4.2	Packing box	15
4.3	Storing prior to commissioning	16
4.4	Transport.....	16
5	Installation	18
5.1	Tools and accessories	18
5.2	Preparing for installation	19
5.3	Fitting the motor (input side)	20
5.4	Fitting the application	22
6	Commissioning	26
6.1	Checks prior to first-time commissioning	26
6.2	Running-in.....	26
6.3	Protective measures for operation.....	27

6.4	Gearbox downtime.....	27
7	Maintenance	28
7.1	Maintenance intervals.....	28
7.2	Replacing lubricants	29
8	Interruption to operations.....	30
9	Service.....	31

1 General information

1.1 Using this operation manual

This operation manual is an integral part of the product and contains all the relevant instructions required to ensure the safe and proper transport, storage, installation, operation and maintenance of the **Neco® gearbox series**.

The **Neco® gearbox series** will be referred to simply as “the gearbox” in the rest of this document.

The operator of the machine is required to ensure that this operation manual has been fully read and understood by all personnel tasked with transport, storage, installation, operation and maintenance.

The operation manual must be kept in a legible condition close to the machine so that it can be accessed at any time.

Make sure that the gearbox you are using is an original product manufactured by Nabtesco Precision Europe GmbH.

There is a QR code on the machine that can be used to access further information online.

Extended operation manuals and supplements are available for special designs. Make sure that you always have all the correct documentation to hand.

You can contact your customer advisor (see Section 9: Service) at any time if you have any questions.

1.2 Warnings

Warnings indicate potential hazards and the consequences if they are not avoided as well as measures that can be taken to prevent danger.

1.2.1 Structure of section-specific warnings

Each section-specific warning applies to an individual section, workflow or procedure. They do not just apply to a specific action. The hazard symbols used will indicate either a general or a specific danger.

Section-specific warnings are structured as follows:

Safety symbol	SIGNAL WORD
	Type of danger and potential consequences
	Measures to prevent the danger

1.2.2 Structure of embedded warnings





Embedded warnings relate to a specific part of a paragraph and apply to smaller units of information than section-specific warnings.

Embedded warnings are structured as follows:

⚠ SIGNAL WORD! Instruction on how to avoid a dangerous situation

1.2.3 Meaning of signal words

The following signal words indicate risks of injury or damage to property:

Signal word	Meaning
	Impending danger Consequence: death or extremely severe injuries
	Possibility of impending danger Consequence: death or extremely severe injuries
	Possibility of impending danger Consequence: slight or minor injuries
	Possibility of impending danger Consequence: damage to property or the environment
	Important information

1.3 Safety and hazard signs

The following safety signs warn of dangers:

	Warning of a hazard zone or dangerous situation
	Warning of hand injuries
	Warning of automatic start-up
	Warning of a hot surface

	Warning of a suspended load
	Warning of the risk of being pulled in
	Warning of the risk of crushing
	Warning of environmental hazards

1.4 Information signs

The following symbol indicates important information:

	NOTE
---	------

1.5 Disclaimer

Compliance with the operation manual is essential to ensure safe operation of the gearbox and to achieve the product and performance characteristics indicated.

Any injury, damage to property or financial loss caused by a failure to follow the operation manual or by transporting, storing, installing, maintaining or operating the gearbox incorrectly will void all warranty and liability claims against Nabtesco Precision Europe GmbH and Nabtesco Corporation.

1.6 Copyright

© 2021 – Nabtesco Precision Europe GmbH. All rights reserved.

Any reproduction, editing, dissemination or other use – in whole or in part – is prohibited.

2 Safety instructions

2.1 Intended use

	NOTE
	<p>The gearbox may only be used under the general conditions described in this operation manual. Any other use requires the written consent of Nabtesco Precision Europe GmbH.</p>

The gearbox is used to modify rotational speeds and torques in mechanical and plant engineering applications and has been designed exclusively for this purpose. The performance limits described must not be exceeded during use. Information on performance can be found in the technical data sheet.

Obtaining comprehensive advice from Nabtesco Precision Europe GmbH is recommended as a basic principle.

2.2 Foreseeable misuse

Any use that exceeds the maximum permitted technical limits (e.g. rotational speeds, power and moment loads) is deemed not to be an intended use and is thus prohibited.

2.3 Installation conditions

Install the gearbox in a location that meets the following criteria:

- ambient temperature -10 °C to +40 °C
- humidity <85% and free of condensation
- installation height <1,000 m above sea level
- good ventilation

Do not install the gearbox:

- anywhere that collects a lot of dust
- anywhere exposed to wind or rain
- close to flammable, explosive or corrosive gases
- close to flammable materials
- anywhere susceptible to magnetic fields or vibrations

	NOTE
	<p>Contact your customer advisor if you cannot achieve the ambient conditions required for installing the gearbox.</p>
	NOTE



Contact your customer advisor if you are using the gearbox in non-standard conditions (e.g. a cleanroom, high-pressure steam, concentrated alkali or equipment for food technology, medical devices, etc.).

2.4 Guidelines

As the gearbox is considered to be a machine component rather than an incomplete machine, it is not covered by the EU Machinery Directive 2006/42/EC.

Fundamental safety and health protection requirements were taken into account when the gearbox was designed and manufactured.

The gearbox may not be commissioned until it has been installed in a machine or incomplete machine that complies with the Machinery Directive 2006/42/EC.

Commissioning cannot take place until the end product's compliance with the EU Machinery Directive has been established.

2.5 Qualifications of personnel

This operation manual is intended for authorised, trained personnel. Only qualified specialists are permitted to perform work such as installation, commissioning and maintenance.

Make sure that all personnel tasked with transporting, storing, installing, operating and maintaining the gearbox have fully read and understood the operation manual.



Ensure that all personnel who spend time in the vicinity of the machine in which the gearbox is to be installed are familiar with the safety instructions.



2.6 General safety instructions



This operation manual contains detailed descriptions for operating the gearbox safely and correctly and for monitoring it during operation.



The gearbox has been constructed in accordance with the state of the art and the accepted rules of safety technology and is deemed safe to operate.



The safety instructions set out below serve to avoid injury and damage to property.

	 WARNING
	<p>Incorrect use, faulty installation or operation and inadequate maintenance can cause major damage to property and serious injuries or even death.</p>
	<p>Follow the general safety instructions in this operation manual. Make sure that the gearbox is used as intended. Only employ qualified specialist personnel.</p>

	 WARNING
	<p>Modifications and work on the gearbox can alter its technical specifications and thus cause major damage to property and serious injuries or even death.</p>
	<p>Do not make any kind of modifications or alterations to the gearbox. Never use the gearbox if any of its parts are damaged.</p>

	 WARNING
	<p>Body parts and clothing can be pulled in by rotating components, causing serious injuries or even death.</p>
	<p>Only ever work on the gearbox when it is at a standstill. Keep a sufficiently safe distance from rotating parts of the gearbox during operation.</p>

	 CAUTION
	<p>The gearbox will become hot during operation. Touching the gearbox case can cause severe burns.</p>
	<p>Before starting work, allow the gearbox to cool down after a sustained standstill. Wear suitable personal protective equipment (protective gloves).</p>

 	CAUTION
	<p>There is the risk of hands and feet being crushed by the weight of the gearbox during handling.</p> <p>Wear suitable personal protective equipment (protective boots, protective gloves).</p>
	ATTENTION
	<p>Lubricants, oils and parts of the gearbox have the potential to pollute the environment.</p> <p>Make sure that the gearbox is disposed of correctly. Check the gearbox regularly for leaks.</p>

3 Description of the gearbox

The gearbox is based on a two-stage concept that reduces or increases incoming rotational speeds and torques in line with the specifications.

The output-side main stage uses the cycloid principle, while the upstream input stage is designed as a spur gear with standard toothing. This combination permits a wide range of gearbox reductions, allowing the gearbox to be adapted in line with customer requirements.

A further benefit is the huge torque density combined with a high level of precision in a minimal installation space.

	NOTE
	All the diagrams below are illustrative and serve only to provide an explanation. Deviations in gearbox size and shape are possible at any time.

3.1 Structure

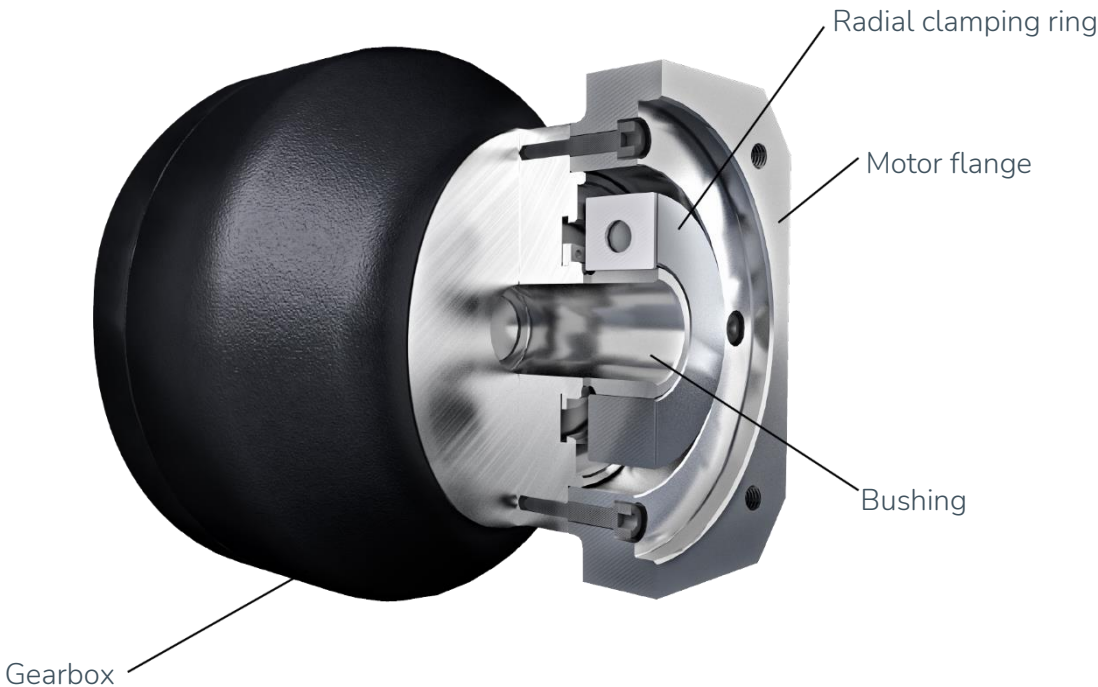

3.2 Technical specifications

You can find technical specifications and product characteristics:

- in the product catalogue
- in the technical data sheet
- on the website www.nabtesco.de/en/downloads

	NOTE
	<p>Designs that have been customised in terms of their technical specifications and geometrics are possible at any time.</p> <p>Please contact Nabtesco Precision Europe GmbH without delay if you are unable to follow the operation manual clearly in this case.</p>

3.3 Product code

G1	125N	A	xx	xxx	x	-	xxxx	-	xxxx	-	xxx
Series	Size	Model	Inside diameter of hollow shaft	Transmission (rated)	Internal code		Motor adaptation		Motor flange design		Lubricant

Please see the product catalogue for more details and descriptions.

3.4 Label

All gearboxes are supplied with a standard Nabtesco Precision Europe GmbH (adhesive) label on the case. This label confirms that the product is a Nabtesco Precision Europe GmbH gearbox. A gearbox can be uniquely identified from its serial number. Make sure that the label is not damaged and remains easily legible when installing the gearbox.

The illustration below shows the structure of the label:

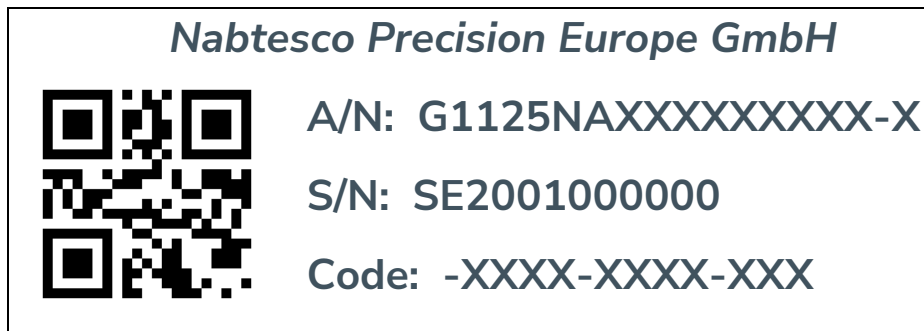

QR code	More information available online
A/N	Article (item) number of the gearbox
S/N	Serial number of the gearbox
Code	Configuration

	NOTE
	The serial number must be quoted in all queries. Customised labels may deviate from the example given above.

3.5 Lubrication

3.5.1 Standard lubricant

All gearboxes are supplied pre-lubricated in line with the specifications.

Nabtesco Precision Europe GmbH provides the following lubricant as standard:

RV-GREASE LB00 (gearbox grease)

Alternative lubricants are available on request.

	ATTENTION
	Exceeding the operating temperature limit will damage the gearbox or shorten its useful life.
	Make sure that the gearbox does not exceed its permitted temperature of 60 °C (measured on its case).

	NOTE
	Only the lubricant recommended by Nabtesco Precision Europe GmbH is to be used.

3.5.2 H1 lubricant – food-safe

Food-safe H1 lubricants are available as an option.

Please contact your customer advisor for more information.

	NOTE
	Food-safe H1 lubricants have different performance characteristics. This can affect the performance specifications as well as the properties of the gearbox. Please speak to your customer advisor about this.

	NOTE
	See Section 7: Maintenance for information on replacing lubricants.

4 Storage and transport

4.1 Scope of supply

As soon as you have received your delivery, check whether the scope of supply matches the information on your delivery documents.

Check your delivery for potential damage sustained in transit. If you spot any such damage, raise a complaint with the freight forwarder without delay.

	<p>⚠ CAUTION</p>
	<p>Damaged components can damage machinery and cause injury.</p>
	<p>Make sure straight away that your delivery is correct, complete and free of damage. If anything is incorrect, contact Nabtesco Precision Europe GmbH without delay.</p>

4.2 Packing box

Make sure that you have received the gearbox in its original packaging. Open the packaging carefully and cautiously to prevent damage.

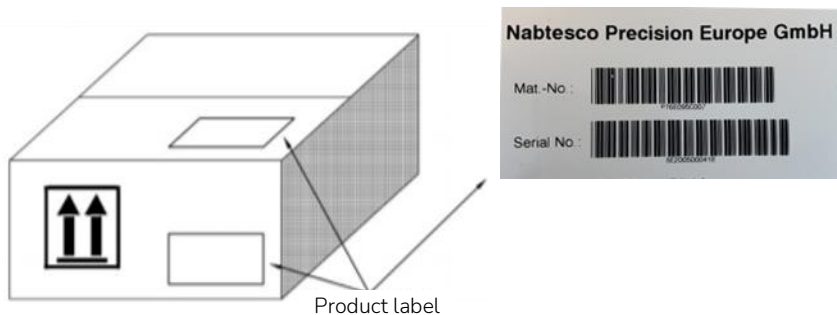

	<p>NOTE</p>
	<p>Have the material and serial number to hand whenever you want to find out any information about this product.</p>

4.3 Storing prior to commissioning

The maximum storage period for the gearbox is 12 months following acceptance of the goods in their original packaging.

Store the gearbox in a location that meets the following criteria:

- at room temperature
- humidity <85% and free of condensation
- not exposed to wind or rain
- not exposed to flammable, explosive or corrosive gases or dust
- not exposed to vibrations
- in a stable location free of hazards

	ATTENTION
	<p>Incorrect storage can damage the gearbox.</p> <p>Keep the time the gearbox spends in storage to a minimum. Store the gearbox in its original packaging.</p> <p>If you are storing the gearbox for a lengthy period of time, check its condition regularly and take anti-corrosion measures if necessary.</p> <p>Bear in mind the warranty period in accordance with the general terms and conditions.</p>



4.4 Transport

Transport the gearbox in an appropriate way in accordance with the weight restrictions specified. Only use suitable lifting equipment to move and lift gearboxes weighing over 20 kg.

Table 1: Gearbox weights



Gearbox type	25N	42N	80N	125N	160N
Approx. weight [kg]	7	12.5	18	26	34.3

	NOTE
	<p>The table only shows the weight of the gearbox itself. The additional weight of the packaging and any optional parts is not included.</p>

	 WARNING
	<p>When the gearbox is being transported as a suspended load, it can fall and cause serious injuries or even death.</p>
<p>Never stand underneath a suspended load.</p> <p>Only use appropriate and correctly sized means of transport and lifting equipment to transport and lift gearboxes.</p> <p>The maximum load-bearing limits of the relevant means of transport must not be exceeded.</p>	

	ATTENTION
	<p>Incorrect transport can damage the gearbox.</p>
<p>Avoid any impacts, vibrations or collisions with other objects through slow and controlled handling.</p> <p>If the gearbox falls or collides with another object, the high-precision components inside it can get damaged.</p> <p>You should stop using the gearbox if this happens.</p>	

5 Installation

	 WARNING
	<p>Failure to follow the safety instructions can cause major damage to property or the environment as well as serious injuries or even death.</p>
	<p>Read the basic safety instructions before starting installation work (see Section 2.6: General safety instructions).</p>

	NOTE
	<p>Make sure that you install the gearbox in the correct environment (see Section 2.3: Installation conditions).</p>

5.1 Tools and accessories

A bushing and a radial clamping ring are supplied as accessory components.

Accessory – bushing

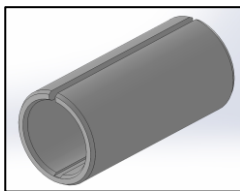

The bushing has been expressly optimised to achieve the desired fitting tolerance. For this reason, only use an original Nabtesco Precision Europe GmbH bushing.

The bushing may not be required depending on the motor adaptation chosen.

Accessory – radial clamping ring

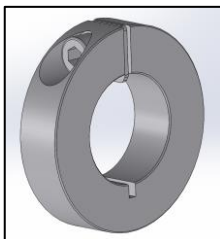

Only use an original Nabtesco Precision Europe GmbH radial clamping ring.

Follow the instructions for tightening it and observe the permitted screw tightening torques.

Table 2 shows the tightening torque required by the clamping screw.

Table 2: Tightening torques for the clamping screw of the radial clamping ring

Size	ID x OD x W	Clamping screw tightening torque
Neco -25	24 x 45 x 11 mm	10 Nm (M5)
Neco -42	32 x 66 x 20 mm	40 Nm (M8)

Neco -80	44 x 82 x 22 mm	84 Nm (M10)
Neco - 125	44 x 82 x 22 mm	84 Nm (M10)
Neco - 160	44 x 82 x 22 mm	84 Nm (M10)

ID = inside diameter / OD = outside diameter / W = width

	NOTE
	<p>As accessory components are custom-manufactured specifically for the gearbox, only use the accessories supplied. Contact your customer advisor if you are unsure.</p> <p>Uncertified accessories can impair gearbox performance. Damage to the gearbox caused by incorrect accessories will void the warranty.</p>

	ATTENTION
	<p>Incorrect installation can lead to a shortened useful life, noisy and unsteady running and a loss of precision.</p>
	<p>Only use suitable tools.</p> <p>Use torque wrenches with a maximum tolerance of +/-5%.</p> <p>The use of gloves is recommended.</p>

5.2 Preparing for installation

The gearbox is supplied in VCI packaging, which can be disposed of as normal waste.

Check all installation surfaces for damage.

The installation surfaces on the input and output sides must be clean, dry and free of grease.

Use a silicone-free degreasing detergent and a clean lint-free cloth.

	NOTE
	<p>Check the requisite components for completeness before commencing installation.</p> <p>Clean the accessories and the installation surfaces prior to starting installation work.</p>

5.3 Fitting the motor (input side)

Check the motor connection prior to installation.

Absolute cleanliness must be ensured during installation.

5.3.1 Terms

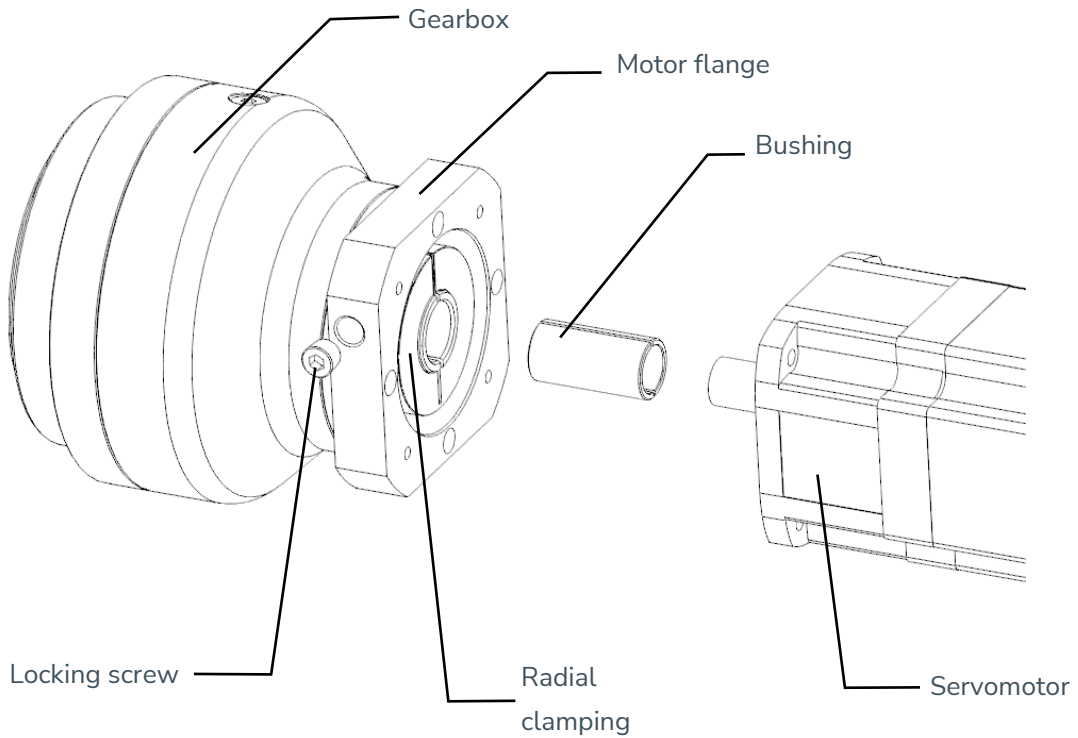



5.3.2 Fitting a motor with a smooth shaft (radial clamping ring connection)

	ATTENTION
	Installing the motor incorrectly can damage the gearbox. Different tolerance values can impair the performance of the clamping connection. The motor shaft may slip.
	Only motors with a smooth shaft and diameter tolerance values in accordance with the gearbox specifications are permitted.

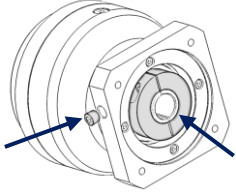
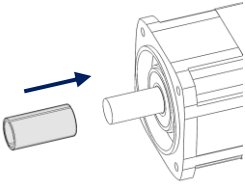
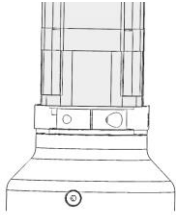
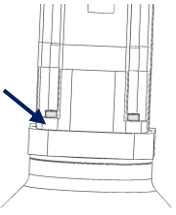
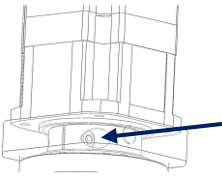
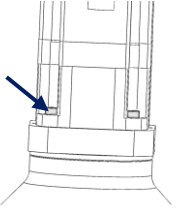
Installation steps

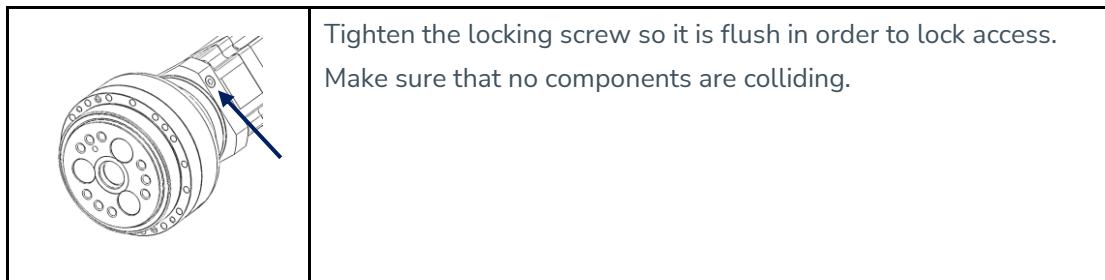
	<p>Remove the locking screw from the motor flange.</p> <p>Slide the radial clamping ring onto the hollow shaft (if not already pre-fitted).</p> <p>The anti-rotation lock (plastic sheet) must lie in the groove of the hollow shaft.</p>
	<p>Slide the bushing onto the motor shaft (optional, if bushing is required).</p>
	<p>Insert the motor with the motor shaft into the hollow shaft of the gear-box until the installation surfaces lie flat and parallel.</p> <p>The slot in the bushing should lie at a 90° angle to the slot in the hollow shaft.</p> <p>A vertical installation position is recommended.</p>
	<p>Use grade 8.8 screws to fix the motor in place.</p> <p>Tighten the screws to 10% of the tightening torque.</p> <p>A screw lock is recommended.</p>
	<p>Tighten the clamping screw to the specified tightening torque in three stages (50%/80%/100%) (see Section 5.1: Tools and accessories, Table 2).</p>
	<p>Tighten the screws to 90% of the tightening torque in a crosswise sequence.</p>



	<p>ATTENTION</p>
	<p>Failure to follow the operation manual can damage the gearbox and impair its technical specifications.</p> <p>For this reason, only use connecting elements specified for motor installation.</p> <p>The tightening torque limits stated in the operation manual must be observed.</p> <p>The loads (bending torque) generated by the motor's own weight must not exceed the permissible screw force. Observe the maximum weights permitted for motors and add-on parts.</p>

5.4 Fitting the application

The installation process is as follows:

Gearbox design A

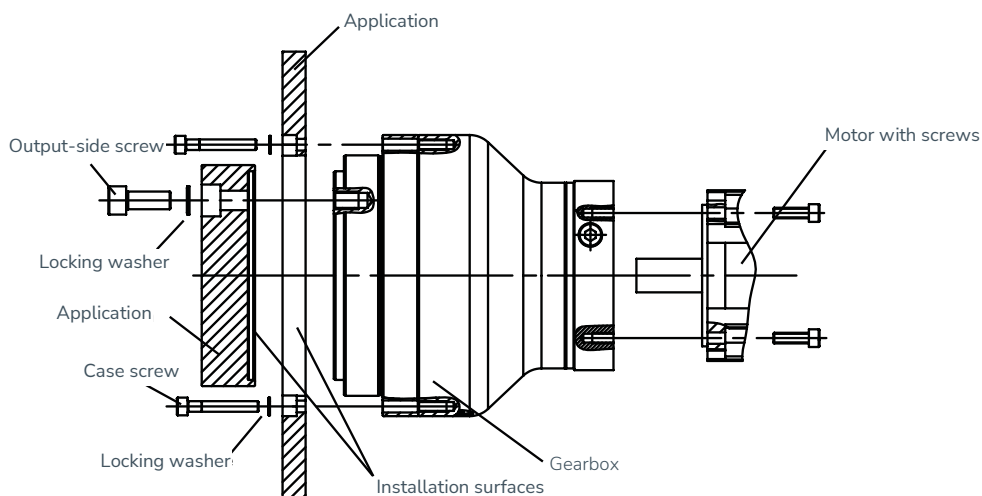

Gearbox design B

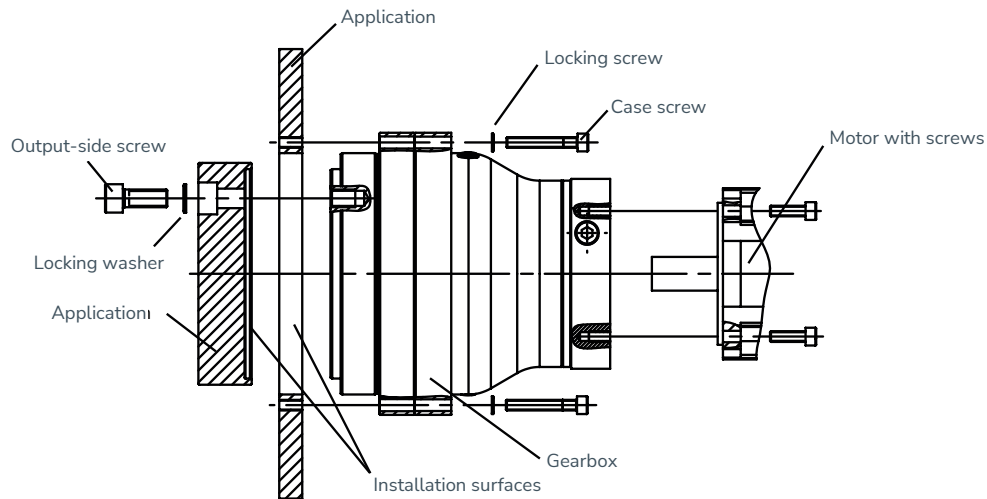

- Make sure that all installation surfaces are free of dirt and burrs.
- Make sure that components are centred and positioned precisely.
- Make sure that the screw connections are accessible in order to prevent damage during installation.
- Use the full complement of screws and make sure that they are long enough (see Tables 3 and 4).
- Use only grade 12.9 screws when installing the flange and case (see 5.3.2 for information on installing the motor), ideally cylinder-head screws in accordance with DIN EN ISO 4762 (DIN 912).
- Use locking washers to prevent the screws from coming loose (see Table 5).
- Tighten all screws gradually in a crosswise sequence, progressing to the next-highest torque each time (see Table 6).

Table 3: Quantity of screws required for the case

Neco	Screw size	Quantity
25	M5 x 0.8	16
42	M6 x 1.0	16
80	M8x 1.25	16
125	M10 x 1.5	16
160	M10 x 1.5	16

Table 4: Quantity of screws required on the output side

Neco	Screw size	Quantity
25	M6 x 1.0	3
	M10 x 1.5	6
42	M10 x 1.5	9
80	M8 x 1.25	24
125	M10 x 1.5	21
160	M12 x 1.75	18

Locking washers

The following locking washers are recommended for use with hexagon socket head cap screws: Belleville spring washer (manufactured by Heiwa Hatsujyo Industry Co., Ltd.)

Code	CDW-H, CDW-L (only for M5)
Material	S50C – S70C
Hardness	HRC40 – 48

Table 5: Locking washers

Nominal size	Inside and outside diameter		t	H
	ID	OD		
5	5.25	8.5	0.6	0.85
6	6.4	10	1.0	1.25
8	8.4	13	1.2	1.55
10	10.6	16	1.5	1.9
12	12.6	18	1.8	2.2
14	14.6	21	2.0	2.5
16	16.9	24	2.3	2.8
18	18.9	27	2.6	3.15
20	20.9	30	2.8	3.55

All figures in mm

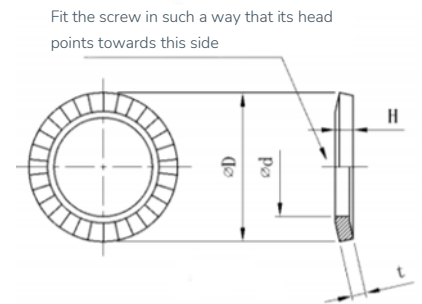



	NOTE
	If you are using a different locking washer, select it based on its outside diameter.

Table 6: Tightening torques for grade 12.9 cylinder-head screws

Nominal size x increase [mm]	Tightening torque* [Nm]	Tightening force (N)
M5 x 0.8	9.01 ± 0.49	9.310
M6 x 1.0	15.6 ± 0.78	13.180
M8 x 1.25	37.2 ± 1.86	23.960
M10 x 1.5	73.5 ± 3.43	38.080
M12 x 1.75	129 ± 6.37	55.100
M14 x 2.0	205 ± 10.2	75.860
M16 x 2.0	319 ± 15.9	103.410
M18 x 2.5	441 ± 22.0	126.720
M20 x 2.5	493 ± 24.6	132.170

*The tightening torque values indicated are valid for steel or cast iron.

6 Commissioning

	⚠ WARNING
	Failure to follow the safety instructions can cause major damage to property as well as serious injuries or even death.
	Read the general safety instructions before performing any work on the gearbox (see Section 2.6: General safety instructions).

	ATTENTION
	Incorrect operation can damage the gearbox.
	Make sure that you use the gearbox as intended in compliance with the technical specifications.

6.1 Checks prior to first-time commissioning

Before commissioning the gearbox, check that:

- lubricant is to hand
- all components are connected up correctly
- the fastening screws are tight
- the direction of rotation is correct

6.2 Running-in

	NOTE
	Only operate the gearbox if all commissioning instructions and information have been observed.

The gearbox needs to be run in for at least 30 minutes at a reduced rotational speed. Use the running-in time to check any unusual noises, vibrations, operating temperature and the tightness of screws.

6.3 Protective measures for operation

	⚠ WARNING
	Body parts and clothing can be pulled in by rotating components, causing serious injuries or even death.
	Keep a sufficiently safe distance from rotating parts of the gearbox during operation.



	ATTENTION
	Unusual noises during operation, excessive vibrations or increased operating temperatures can damage the gearbox.
	Discontinue operation. Find the cause of the fault. Eliminate it after consulting Nabtesco Precision Europe GmbH.



6.4 Gearbox downtime



If the gearbox has been at a standstill for a lengthy period of time, check that no corrosion is present before commissioning it. Operating the gearbox without performing these checks can damage it.

	NOTE
	The commissioning process must be repeated if the gearbox has been at a standstill for a lengthy period of time. Repeating the running-in process is also recommended.

7 Maintenance

	 WARNING
	<p>Failure to follow the safety instructions can cause major damage to property as well as serious injuries or even death.</p>
	<p>Read the general safety instructions before performing any work on the gearbox (see Section 2.6: General safety instructions).</p>

	 WARNING
	<p>If the drive system starts up unintentionally while work is being carried out on the gearbox, this can cause serious injuries or even death.</p>
	<p>Cut the power to the gearbox motor before starting work and make sure that the gearbox cannot be switched on unintentionally.</p>

	 CAUTION
	<p>Risk of burns due to a hot gearbox and hot lubricant. Touching the gearbox case can cause severe burns.</p>
	<p>Before starting work, allow the gearbox to cool down after a sustained standstill. Wear suitable personal protective equipment (protective gloves).</p>

7.1 Maintenance intervals

Time interval	Checks
On commissioning and regularly at more frequent intervals	Check of noises during operation
	Check of operating temperature
	Visual check of seals for leaks
	Check of fastening screws

Commission the gearbox correctly (see Section 6: Commissioning). Operate the gearbox in line with the technical specifications.

If unplanned interruptions to operations occur, follow the instructions in this operation manual (see Section 8: Interruptions to operations).

7.2 Replacing lubricants

Lubricants should be replaced after 20,000 hours of operation at an average operating temperature of max. 40 °C.

The condition of the lubricant must be monitored in extreme operating conditions such as high humidity, persistently high operating temperatures or an aggressive environment. It may be necessary to replace lubricants more frequently.

8 Interruption to operations

Fault	Potential cause	Remedial action
Unusual noises or vibrations during operation	Damage in storage	Contact customer advisor
	Irregular tothing	
	Motor not fitted correctly	
Increased operating temperature	Ambient temperature too high	Ensure sufficient cooling
	Motor making gearbox hot	Ensure sufficient cooling
	Gearbox not suited to operating conditions	Check technical specifications
Loss of lubricant	Faulty seal	Contact customer advisor



NOTE

If you need help from your customer advisor, please provide us with the following information:

- label data
- type of fault
- time of fault
- suspected cause

9 Service

Please contact your customer advisor if you have any questions or problems. We would be happy to help you.

Please use the following contact details:

Address	Nabtesco Precision Europe GmbH Tiefenbroicher Weg 15 D-40472 Düsseldorf, Germany
Telephone	+49 211 173790
Email	info@nabtesco.de
Internet	www.nabtesco.de